

THINK ELECTRICAL

**ORION MODULAR SOCKETS & SWITCHES**

**NEW**

# ORION MODULAR SOCKETS & SWITCHES 2 x 4 RANGE

Switches						Pushbuttons, Dimmers
16A   240VAC 2 x 4						
<b>Code</b>	<b>M7001M-*</b>	<b>M7002M-*</b>	<b>M7003HM-*</b>	<b>M7004-M-*</b>	<b>M7006-HM-*</b>	<b>M7001-2M-*</b>
Description	1 Lever 1 Way	2 Lever 1 Way	3 Lever 1 Way	4 Lever 1 Way	6 Lever 1 Way	1 x 1P 16A Pushbutton
<b>Code</b>	<b>M7011M-*</b>	<b>M7012M-*</b>	-	-	-	<b>M7001-2M-D-*</b>
Description	1 Lever 2 Way	2 Lever 2 Way	-	-	-	1 x 1P 16A Pushbutton & Shuttle 500W Dimmer

\*Add Colour to Code: ○ WH (White), ○ MW (Matt White), ○ IV (Ivory), ● CA (Charcoal), ● BK (Black), ● CH (Champagne)

## Standard Sockets

	3 gang	3 gang	4 gang	6 gang
<b>Code</b>	<b>M7300-*</b>	<b>M7302-*</b>	<b>M7601-*</b>	<b>M7602-*</b>
Description	1 x SA 16A Switched Socket Outlet	3 x N-Type SA 16A Socket Outlets	1 x SA 16A + 2 x N-Type SA 16A Socket Outlets	2 x SA 16A + 2 x N-Type SA 16A Socket Outlets

\*Add Colour to Code: ○ WH (White), ○ MW (Matt White), ○ IV (Ivory), ● CA (Charcoal), ● BK (Black), ● CH (Champagne)

	6 gang	8 gang
<b>Code</b>	<b>M7603-*</b>	<b>M7604-*</b>
Description	1 x SA 16A + 2 x N-Type SA 16A 2 x 2.1A USB Chargers	1 x SA 16A + 1 x Multi Socket + 2 x N-Type SA 16A Socket + 2 x 2.1A USB Chargers

\*Add Colour to Code: ○ WH (White), ○ MW (Matt White), ○ IV (Ivory), ● CA (Charcoal), ● BK (Black), ● CH (Champagne)

## USB Sockets

	3 gang	3 gang	3 gang	3 gang	3 gang
<b>Code</b>	<b>M7303-*</b>	<b>M7304-*</b>	<b>M7305-*</b>	<b>M7801-*</b>	<b>M7802-*</b>
Description	1 x N-Type SA 16A Switched Socket Outlet + 2.1A USB Charger	2 x 2.1A USB Charger	1 x USBC Port 1 x 2.1A USB Charger	1 x RJ11 socket	2 x RJ11 sockets

\*Add Colour to Code: ○ WH (White), ○ MW (Matt White), ○ IV (Ivory), ● CA (Charcoal), ● BK (Black), ● CH (Champagne)

## Data Sockets

## TV Sockets

	3 gang	3 gang	3 gang	3 gang
<b>Code</b>	<b>M7803-*</b>	<b>M7804-*</b>	<b>M7805-*</b>	<b>M7806-*</b>
Description	1 x CAT 6 (RJ45) FTP socket	2 x CAT 6 (RJ45) UTP sockets	1 x TV Outlet 1 x SAT Outlet	SAT Outlet

\*Add Colour to Code: ○ WH (White), ○ MW (Matt White), ○ IV (Ivory), ● CA (Charcoal), ● BK (Black), ● CH (Champagne)

**NEW**

# ORION MODULAR SOCKETS & SWITCHES 4 x 4 RANGE

## Standard Sockets (4x4)

<b>Code</b>	<b>M7401-*</b>	<b>M7401A-*</b>	<b>M7402-*</b>	<b>M7403-*</b>	<b>M7404-*</b>
<b>Description</b>	1 x SA 16A Switched Socket Outlet	1 x SA 16A Switched Socket Outlet	2 x SA 16A Switched Socket Outlets	1 x SA 16A + 2 x N-Type 16A SA Switched Socket Outlets	1 x SA 16A Switched Socket Outlet + 3 x N-Type 16A SA

\*Add Colour to Code: ○ WH (White), ○ MW (Matt White), ○ IV (Ivory), ● CA (Charcoal), ● BK (Black), ● CH (Champagne)

<b>Code</b>	<b>M7405-*</b>	<b>M7407-*</b>	<b>M7412-*</b>	<b>M7413-*</b>	<b>M7414-*</b>
<b>Description</b>	2 x SA 16A + 2 x N-Type 16A SA Socket Outlet	3 x N-Type 16A SA Socket Outlet	1 x Schuko Switched Socket Outlet, 1 x 16A Switched Socket Outlet	2 x Schuko Switched Socket Outlet	2 x N-Type 16A Socket Outlet, 1 x Schuko Outlet, 1 x 16A Socket Outlet

\*Add Colour to Code: ○ WH (White), ○ MW (Matt White), ○ IV (Ivory), ● CA (Charcoal), ● BK (Black), ● CH (Champagne)

## USB Chargers (4x4)

<b>Code</b>	<b>M7406-*</b>	<b>M7408-*</b>	<b>M7409-*</b>	<b>M7410-*</b>	<b>M7411-*</b>
<b>Description</b>	2 x SA 16A + 1 x N-Type 16A SA Socket Outlet + 2.1A USB Charger	4 x N-Type 16A SA Socket Outlet + 2 x 2.1A USB Charger	1 x SA 16A Switched Socket Outlet + 2 x N-Type 16A SA + 2.1A USB Charger	2 x 2.1A USB Charger Socket Outlets	1 x N-Type 16A Socket Outlet, 1 x Schuko Outlet, 1 x 2.1A Switched USB Charger, 1 x 16A Socket Outlet

\*Add Colour to Code: ○ WH (White), ○ MW (Matt White), ○ IV (Ivory), ● CA (Charcoal), ● BK (Black), ● CH (Champagne)

## Dedicated Sockets (4x4)

	3 gang			
<b>Code</b>	<b>M7500-*</b>	<b>M7501-*</b>	<b>M7502-*</b>	<b>M7503-*</b>
<b>Description</b>	1 x Red Dedicated 3 pin 16A Switched Socket Outlet	1 x Red Dedicated 3 pin 16A Switched Socket Outlet	2 x Red Dedicated 3 pin 16A Switched Socket Outlets	1 x SA 16A + 1 x Red Dedicated 3 pin 16A Switched Socket Outlets

\*Add Colour to Code: ○ WH (White), ○ MW (Matt White), ○ IV (Ivory), ● CA (Charcoal), ● BK (Black), ● CH (Champagne)

NEW

# ORION MODULAR SOCKETS & SWITCHES RANGE

## Switches (3x3)

<b>Code</b>	<b>M750L1-1*</b>	<b>M750L2-1*</b>	<b>M750-L1B*</b>
Description	1 Lever 1 Way	2 Lever 1 Way	1 x 1P 16A Pushbutton
<b>Code</b>	<b>M750L1-2*</b>	<b>M750L2-2*</b>	<b>M750-500-DIM*</b>
Description	1 Lever 2 Way	2 Lever 2 Way	500W Dimmer

\*Add Colour to Code: ○ WH (White), ○ MW (Matt White), ○ IV (Ivory), ● CA (Charcoal), ● BK (Black), ● CH (Champagne)

## Sockets (3x3)

<b>Code</b>	<b>M750-16SA*</b>	<b>M750-2N*</b>	<b>M750-NU*</b>	<b>M750-UC*</b>	<b>M750-10M*</b>	<b>M750-16SC*</b>
Description	1 x SA 16A Socket Outlet	2 x N-Type SA 16A Socket Outlet	1 x N-Type SA 16A Socket Outlet + 2,1A USB Charger	1 x USBC Port 1 x 2.1A USB Charger	10A Multi Socket Outlet	16A Schuko Socket Outlet

\*Add Colour to Code: ○ WH (White), ○ MW (Matte White), ○ IV (Ivory), ● CA (Charcoal), ● BK (Black), ● CH (Champagne)

<b>Code</b>	<b>M750-2USB*</b>	<b>M750-13UK</b>	<b>M750-2RJ*</b>	<b>M750-2UTP*</b>	<b>M750-1TVS*</b>	<b>M750-160SA*</b>
Description	Dual Port Charger 5VDC, 4.2A (TOT)	13A British Socket	2 x RJ12 Socket	2 x CA6 UTP Socket	1 x TV Outlet 1 x SAT Outlet	Dedicated 16A SA Socket

\*Add Colour to Code: ○ WH (White), ○ MW (Matte White), ○ IV (Ivory), ● CA (Charcoal), ● BK (Black), ● CH (Champagne)

## Switched Sockets (3x3)

<b>Code</b>	<b>K750-13UK</b>	<b>K750-15UK</b>	<b>K750-45L1</b>
Description	13A BS Switched Socket	1 x 3 Pin SA Switched Socket	45A DP Isolator with Neon

\*Add Colour to Code: ○ WH (White), ○ MW (Matte White), ○ IV (Ivory), ● CA (Charcoal), ● BK (Black), ● CH (Champagne)

## Switched Sockets (3x6)

## Smart Switches (3x3)

<b>Code</b>	<b>K750-13UK-2</b>	<b>K750-45L1-C</b>	<b>M750-S1*</b>	<b>M750-S2*</b>
Description	2 x 13A BS Switched Socket	Cooker Control Unit	1 Way Smart 16A Tuya Switch	2 x 1 Way Smart 16A Tuya Switch

\*Add Colour to Code: ○ WH (White), ○ MW (Matte White), ○ IV (Ivory), ● CA (Charcoal), ● BK (Black), ● CH (Champagne)

**NEW**

# MONO BLOCK

## Sockets

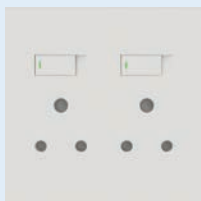

Code	M7402	M7404	M7411
Desc.	2 x 16A Switched Socket (4 x 4)	1 x N-Type + 1 x 16A + 2 x USB SV, 500mA Outputs (4 x 4)	Single Switched Socket - 1 x 16A + 1 x IEC + 1 x Schuko (4 x 4)

\*Add Colour to Code: ○ WH (White), ○ MW (Matte White), ○ IV (Ivory), ● CA (Charcoal), ● BK (Black), ● CH (Champagne)

## Isolators



Code	M7901-*	M7902-*	M7903-*
Desc.	Stove Isolator 32A DP (2x4)	Stove Isolator 45A DP (4x4)	Stove Isolator 50A 3P (4x4)

\*Add Colour to Code: ○ WH (White), ○ MW (Matte White), ○ IV (Ivory), ● CA (Charcoal), ● BK (Black), ● CH (Champagne)





# ORION MODULAR RANGE ASSEMBLY

Make your own socket and switch plates to fit your needs.

Choose the plate size and then add the modules to fill the frame size.

Note: A 2 Gang frame can have two single size (thin) modules and a 4 Gang plate can have four single size (thin) modules. A double module (the size of two singles) is easy to spot as it has a square shape - if you choose a double module, you obviously will have fewer single modules e.g. a 4 Gang plate can have one double and two single modules (instead of the normal four singles).

Choose your module colour to match the plate/trim, a modular plate with a white trim usually has white modules in it.

**Order of assembly:**

1. Choose wall box
2. Match Frame to existing wall box
3. Configure module layout
4. Add cover plate

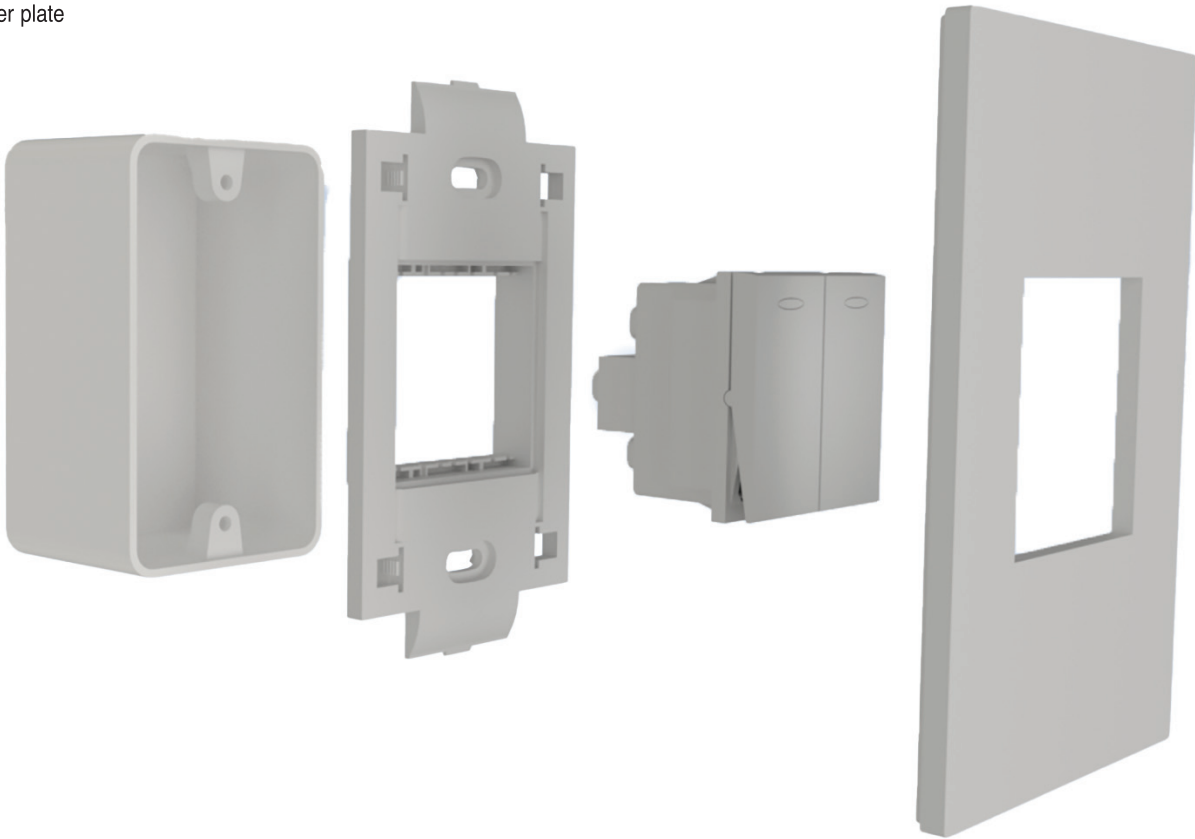

## COLOUR CHART

○ WH

○ MW

○ IV

● BK

● CA

● CH

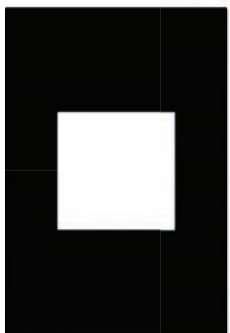
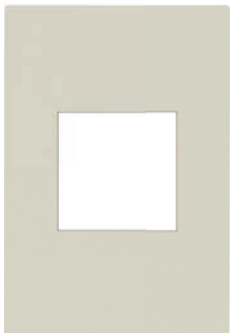

WHITE

MATTE WHITE

IVORY

MATT BLACK

CHARCOAL

CHAMPAGNE

## 2X4 WALL BOXES

TM-2020  
Conforms to SABS Spec. No. IEC60670-1

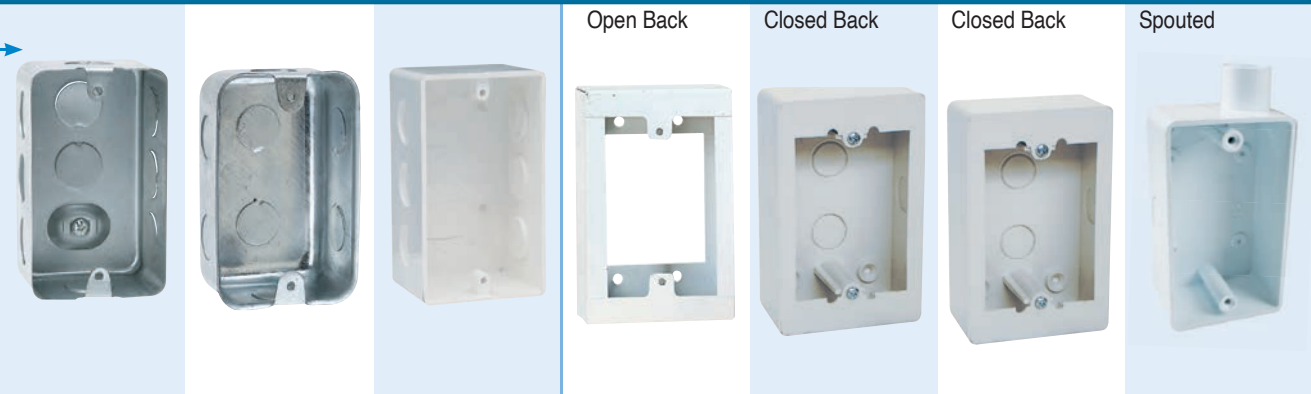

Code	TM-2020	TM-42S	TC-PR42	EB42	EB42C	PEB42	SPEB42
Description	105.5 x 61 x 50D Steel Flush Mount	105 x 65 x 45D Steel Flush Mount	105 x 61 x 50D Plastic Flush Mount	50 x 100 Steel Surface Mount	50 x 100 Steel Surface Mount	50 x 100 Plastic Surface Mount	50 x 100 Plastic Surface Mount

## 4X4 WALL BOXES

TM-4040  
Conforms to SABS Spec. No. IEC60670-1



Code	TM-4040	TM-44S	TC-PR44	EB44	EB44C	PEB44	SPEB44
Description	105.5 x 105.5 x 50D Steel Flush Mount	105 x 105 x 45D Steel Flush Mount	105 x 105 x 50D Plastic Flush Mount	100 x 100mm Steel Surface Mount	100 x 100mm Steel Surface Mount	100 x 100mm Plastic Surface Mount	100 x 100mm Plastic Surface Mount

## 3X3 WALL BOXES

### Galvanised Steel Flush Mount

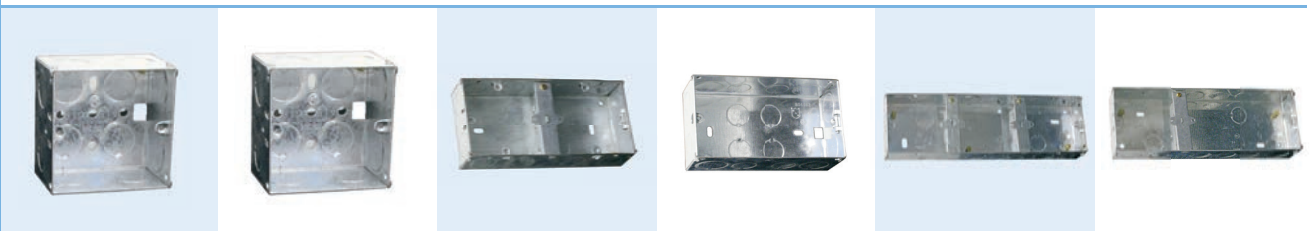

Code	TM-SG135	TM-SG147	TM-SG235D	TM-SG247	TM-SG335	TM-SG335D
Description	3x3 71 x 71 x 35mm	3x3 71 x 71 x 47mm	2x3x3 151 x 71 x 35mm	6x3 131 x 71 x 35mm	3x3x3 248 x 71 x 35mm	1x3x3 + 1x6x3 215 x 71 x 35mm



Code	BEL-B1	BEL-C1	BEL-B2	BEL-C2	SC4X40	SC4X75
Description	3x3 75 x 75 x 37mm	6x3 132 x 72 x 37mm	3x3 86 x 86 x 30mm	6x3 148 x 88 x 32mm	4 x 40mm with counter sunk head, Pack of 50	4 x 75mm

**NEW**

## ORION MODULAR RANGE

<b>Code</b>	<b>M724S2</b>	<b>M724C2G-*</b>	<b>M724S3G</b>	<b>M724C3G-*</b>
Description	2 Gang Support Frame   White	2 Gang Cover Plate	3 Gang Support Frame   White	3 Gang Cover Plate
Wall Box	2 x 4	2 x 4	2 x 4	2 x 4

\*Add Colour to Code: ○ WH (White), ○ MW (Matte White), ○ IV (Ivory), ● CA (Charcoal), ● BK (Black), ● CH (Champagne)

<b>Code</b>	<b>M744S3G</b>	<b>M744C3G-*</b>	<b>M744S6G</b>	<b>M744C6G-*</b>
Description	3 Gang Support Frame   White	3 Gang Cover Plate	6 Gang Support Frame   White	6 Gang Cover Plate
Wall Box	4 x 4	4 x 4	4 x 4	4 x 4

\*Add Colour to Code: ○ WH (White), ○ MW (Matte White), ○ IV (Ivory), ● CA (Charcoal), ● BK (Black), ● CH (Champagne)

<b>Code</b>	<b>M733S2G</b>	<b>M733C2G-*</b>	<b>M736S4G</b>	<b>M736C4G-*</b>
Description	2 Gang Support Frame   White	2 Gang Cover Plate	4 Gang Support Frame   White	4 Gang Cover Plate
Wall Box	3 x 3	3 x 3	3 x 6	3 x 6

\*Add Colour to Code: ○ WH (White), ○ MW (Matte White), ○ IV (Ivory), ● CA (Charcoal), ● BK (Black), ● CH (Champagne)

<b>Code</b>	<b>M739S6G</b>	<b>M739C6G-*</b>
Description	6 Gang Support Frame   White	6 Gang Cover Plate
Wall Box	3 x 9	3 x 9

\*Add Colour to Code: ○ WH (White), ○ MW (Matte White), ○ IV (Ivory), ● CA (Charcoal), ● BK (Black), ● CH (Champagne)

<b>Code</b>	<b>M7312S8G</b>	<b>M7312C8G-*</b>
Description	8 Gang Support Frame   White	8 Gang Cover Plate
Wall Box	3 x 12	3 x 12

\*Add Colour to Code: ○ WH (White), ○ MW (Matte White), ○ IV (Ivory), ● CA (Charcoal), ● BK (Black), ● CH (Champagne)



**NEW**

## 45 X 45MM MODULES

### Switches

<b>Code</b>	<b>SA-F1-*</b>	<b>SA-F3-*</b>	<b>SA-F1-2-*</b>	<b>SA-F1PB-*</b>	<b>SA-F1-I-*</b>	<b>SA-F2-*</b>
Description	1 Way Switch	2 x 1 Way Switch	2 Way Switch	Push Button	Intermediate	1 Way Switch
Current	16A	16A	16A	16A	16A	16A
Module Size	1M	1M	1M	1M	1M	2M
<b>Code</b>	<b>SA-F2-2-*</b>	<b>SA-F2PB-*</b>	<b>SA-P2-I-*</b>	<b>SA-I2-32-*</b>	<b>SA-I2-45-*</b>	<b>SA-I2-50-*</b>
Description	2 Way Switch	Push Button	Intermediate	Isolator Switch	Isolator Switch	Isolator Switch
Current	16A	16A	16A	32A DP	45A DP	50A 3P
Module Size	2M	2M	2M	2M	2M	2M

\*Add Colour to Code: ○ WH (White), ● BK (Black)

### Sockets

<b>Code</b>	<b>SA-F30-N-*</b>	<b>SA-F30-*</b>	<b>SA-F30-S-*</b>	<b>SA-F30D</b>	<b>SA-F30D-S</b>	<b>SA-F30D-BL</b>
Description	N-Type Socket	SA Socket	16A Switched Socket	SA Socket	16A Switched Socket	16A Switched Socket
Current	16A	16A	16A	16A	16A	16A
Module Size	1M	2M	3M	2M	3M	3M

\*Add Colour to Code: ○ WH (White), ● BK (Black)

### Sockets

### USB Port Connectors

<b>Code</b>	<b>SA-F5-*</b>	<b>SA-F6-*</b>	<b>SA-F9-*</b>	<b>SA-F21C-*</b>	<b>SA-F21-C3-*</b>	<b>SA-F21-C4-*</b>
Description	3Pin Multi	Schuko Socket	British Socket	Dual Port Charger	Dual Port Charger	Dual Port Charger
Current	10A	16A	13A	5VDC, 2.1A (Tot.)	5VDC, 4.2A (Tot.)	5VDC, 2.1A (Tot.)
Module Size	2M	2M	2M	1M	2M	2M

\*Add Colour to Code: ○ WH (White), ● BK (Black)

### Blank

### Audio & Video Ports

<b>Code</b>	<b>SA-F10-*</b>	<b>SA-F21-*</b>	<b>SA-F25-*</b>	<b>SA-F22-*</b>	<b>SA-F23-*</b>	<b>SA-F24-*</b>	<b>SA-F26-*</b>
Description	Blanking Plate	USB Connector	HDMI Connector	VGA Female	VGA Male	Kalon	S Video
Module Size	1M	1M	1M	1M	1M	1M	1M

\*Add Colour to Code: ○ WH (White), ● BK (Black)

**NEW**

## 45 X 45MM MODULES

	Audio & Video Ports			Telecom & Data Ports		
<b>Code</b>	<b>SA-F15-*</b>	<b>SA-F13-*</b>	<b>SA-F14-*</b>	<b>SA-F11-*</b>	<b>SA-F12-*</b>	<b>SA-F12A-*</b>
Description	TV Socket	RCA Audio	RCA Video	RJ12	RJ45 (CAT5)	RJ45(CAT6)
Module Size	1M	1M	1M	1M	1M	1M









\*Add Colour to Code: ○ WH (White), ● BK (Black)

	TV / SAT / FM Modules				tuya® 45 x 45 Smart Modules (WiFi)	
<b>Code</b>	<b>SA-F16-*</b>	<b>SA-F17-*</b>	<b>SA-F18-*</b>	<b>SA-F19-*</b>	<b>SA-F15M-*</b>	<b>SA-F25M-*</b>
Description	Coaxial TV Socket Outlet	TV/SAT Outlet	TV/FM/SAT Outlet		1 Way 16A Smart Switch - TUYA	1 Way Smart 16A Switch - TUYA
Module Size	1M	1M	2M	2M	1M	2M

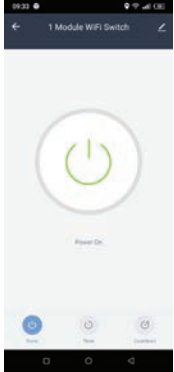
\*Add Colour to Code: ○ WH (White), ● BK (Black)

**NEW**







## 45 X 45 SMART MODULAR SYSTEMS

	WiFi Switches		
<b>Switch Modules</b> Voltage Rating: 100-240VAC	 WiFi Control	 WiFi Control	
<b>Code</b>	<b>SA-F42</b>	<b>SA-F43</b>	    
<b>Description</b>	1 Way Pushbutton	1 Way Pushbutton	
<b>Load</b>	16A	16A	
<b>Dimensions</b>	1M	2M	

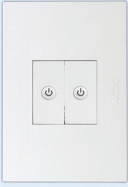
Add the WiFi Switch Modules to your ACDC SMART app to control remotely. See pg 571 in the ACDC Main Catalogue for more modules, support frames and cover plates.



**NEW**

## SMART MODULAR SOCKETS & SWITCHES





	Smart Switches			Smart Sockets
				
<b>Code</b>	<b>SM7001-WH</b>	<b>SM7002-WH</b>	<b>SM7003-WH</b>	<b>SM7401-WH</b>
<b>Description</b>	1 x 1 Way 16A Smart Switch	2 x 1 Way 16A Smart Switch	3 x 1 Way 16A Smart Switch	1 x Smart Switched 16A Socket Outlet
	Smart Sockets			
				
<b>Code</b>	<b>SM7403-WH</b>	<b>M7808-WH</b>	<b>M7809-WH</b>	
<b>Description</b>	1 x Smart Switched 16A Socket Outlet, 1 x Smart Switched 2 x N-Type 16A Socket Outlet	2 x 16A Socket Outlet, 1 x Smart Switched N-Type 16A Outlet	2 x Smart Switched 16A N-Type Socket Outlet	

**NEW**

## 45 x 45 SMART MODULAR Wi-Fi WATERPROOF SOCKETS IP55

	Smart Sockets		
			
<b>Code</b>	<b>SM34853</b>	<b>SM38844</b>	<b>SM343312</b>
<b>Description</b>	1 x Smart Switched Waterproof SA 16A Socket	2 x Smart Switched Waterproof SA 16A Socket	2 x Smart Switched Waterproof N-Type 16A Socket





Input Voltage: AC100-240V | PC Plastic

WIRING ACCESSORIES & SILUX

NEW

# B7000 SMART WIFI SWITCH MODULES

	Pico WiFi Switch	Pico WiFi Dimmer	Pico Slave
<b>Code</b>	<b>AS-PICO-SW</b>	<b>AS-PICO-DIM</b>	<b>AS-PICO-SL</b>
<b>Description</b>	• On/Off Switching • Neutral Required	• On/Off Switching + dimming • Neutral Required	• Used to duplicate switch or dimmer • No Neutral required
<b>Connected Load</b>	10-300VA LED (1-15) Resistive loads - Max. 200W	10-300VA LED (1-15) Resistive loads - Max. 200W	-
<b>Dimensions</b>	21 x 21 x 40mm	21 x 21 x 40mm	21 x 21 x 40mm
<b>Functions</b>	• App Control • Switching • Schedules	• App Control • Dimming & Switching • Schedules	Manual Switch (only with no-app control)

- Input Voltage 220-240VAC, 50Hz.
- Smart Mobile App for end user.

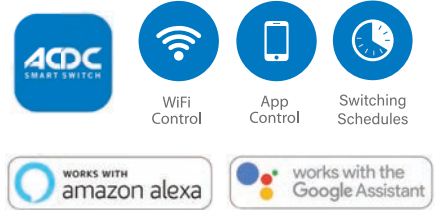

### App UI

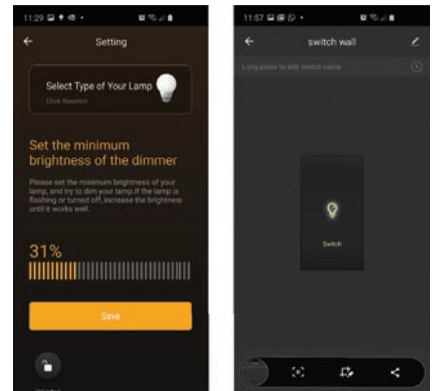

Dimmer Settings

Tap to turn on-off

B7000 Cover Plates - For PICO Wi-Fi Switch Modules	
Blank plates with cradles to accommodate the WiFi Pico Switches	
<b>Code</b>	<b>A7105D</b>
<b>Description</b>	(4 x 2) 1 lever for Pico Wi-Fi Switches
<b>Code</b>	<b>A7106D</b>
<b>Description</b>	(4 x 2) 1 lever for Pico Wi-Fi Switches and 1 lever for HY Dimmers

### Wiring Diagram

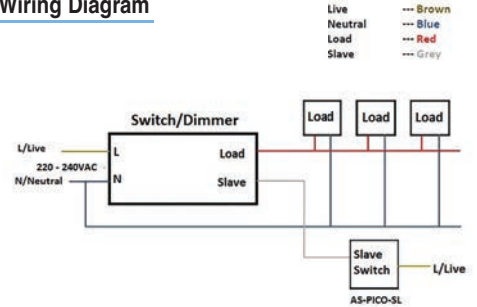

See pg556 in the Main Catalogue for HY Dimmers

# SMART WIFI SWITCH MODULE



The Wifi Switch is Connected in-line with the Lights or Home Appliance you wish to Control.

Code	Input Voltage	Max Load	Size (mm)
<b>AS-NF-101</b>	100-240VAC	16A	88 x 39 x 22

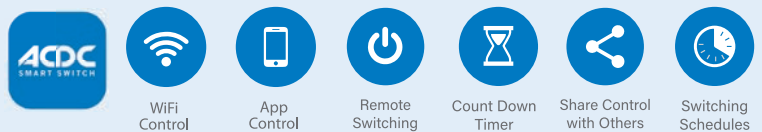

### Wiring Diagram

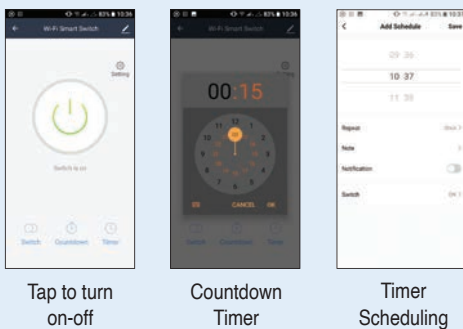

Tap to turn on-off

Countdown Timer

Timer Scheduling

NEW

## 4 x 2 SMART WIFI TOUCH SWITCHES



- Input Voltage: 160-240VAC
- The WiFi Switches can work with No Neutral
- Add Capacitor to work with No Neutral.

### Wall Plates (125 x 80mm)

### Intelligent Modules

#### Light Switches - No Neutral Required

<b>Code</b>	<b>WF7001P-WH</b>	<b>WF7001P-BK</b>	<b>WF7001P-G</b>	<b>WF7001</b>
<b>Description</b>	1 Gang (4x2) Glass White Plate	1 Gang (4x2) Glass Black Plate	1 Gang (4x2) Glass Gold Plate	1 Gang (4x2) Max. Load (1000W)
<b>Code</b>	<b>WF7002P-WH</b>	<b>WF7002P-BK</b>	<b>WF7002P-G</b>	<b>WF7002</b>
<b>Description</b>	2 Gang (4x2) Glass White Plate	2 Gang (4x2) Glass Black Plate	2 Gang (4x2) Glass Gold Plate	2 Gang (4x2) Max. Load (2x1000W)
<b>Code</b>	<b>WF7003P-WH</b>	<b>WF7003P-BK</b>	<b>WF7003P-G</b>	<b>WF7003</b>
<b>Description</b>	3 Gang (4x2) Glass White Plate	3 Gang (4x2) Glass Black Plate	3 Gang (4x2) Glass Gold Plate	3 Gang (4x2) Max. Load (3x1000W)
<b>Code</b>	<b>WF7004P-WH</b>	<b>WF7004P-BK</b>	<b>WF7004P-G</b>	<b>WF7004</b>
<b>Description</b>	4 Gang White Crystal Glass Plate	4 Gang Black Crystal Glass Plate	4 Gang Gold Crystal Glass Plate	4 Gang Max. Load (4 x 1000W)

#### Curtain Switches - Neutral Required | Works with 3-wire curtain motors

<b>Code</b>	<b>WCU700-WH</b>	<b>WCU700-BK</b>	<b>WCU700-G</b>	<b>WCU700</b>
<b>Description</b>	Glass White Plate	Glass Black Plate	Glass Gold Plate	Curtain Switch Module Max. Load (1000W)

#### Light Dimmers - Neutral Required

<b>Code</b>	<b>WD700-WH</b>	<b>WD700-BK</b>	<b>WD700-G</b>	<b>WD700</b>
<b>Description</b>	Glass White Plate	Glass Black Plate	Glass Gold Plate	Light Dimming Module Max. Load (300W)





# 3 x 3 SMART WI-FI SWITCHES

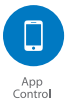

- Input Voltage: 160-240VAC
- The WiFi Switches can work with No Neutral
- Add Capacitor to work with No Neutral.

	Wall Plates			Intelligent Modules
<b>Light Switches - No Neutral Required</b>				
Remote Switching	<b>WF3001P-WH</b>	<b>WF3001P-BK</b>	<b>WF3001P-G</b>	<b>WF3001</b>
Description	1 Gang (3x3) Crystal Glass White Plate	1 Gang (3x3) Crystal Glass Black Plate	1 Gang (3x3) Crystal Glass Gold Plate	1 Gang (3x3) Max. Load (1000W)
Remote Switching	<b>WF3002P-WH</b>	<b>WF3002P-BK</b>	<b>WF3002P-G</b>	<b>WF3002</b>
Description	2 Gang (3x3) Crystal Glass White Plate	2 Gang (3x3) Crystal Glass Black Plate	2 Gang (3x3) Crystal Glass Gold Plate	2 Gang (3x3) Max. Load (2x1000W)
Remote Switching	<b>WF3003P-WH</b>	<b>WF3003P-BK</b>	<b>WF3003P-G</b>	<b>WF3003</b>
Description	3 Gang (3x3) Crystal Glass White Plate	3 Gang (3x3) Crystal Glass Black Plate	3 Gang (3x3) Crystal Glass Gold Plate	3 Gang (3x3) Max. Load (3x1000W)
Remote Switching	<b>WF3004P-WH</b>	<b>WF3004P-BK</b>	<b>WF3004P-G</b>	<b>WF3004</b>
Description	4 Gang White Crystal Glass Plate	4 Gang Black Crystal Glass Plate	4 Gang Gold Crystal Glass Plate	4 Gang Max. Load (4 x 1000W)
<b>Curtain Switches - Neutral Required   Works with 3-wire curtain motors</b>				
Open/Close Curtain	<b>WCU300-WH</b>	<b>WCU300-BK</b>	<b>WCU300-G</b>	<b>WCU300</b>
Description	Crystal Glass White Plate	Crystal Glass Black Plate	Crystal Glass Gold Plate	Curtain Switch Module Max. Load (1000W)
<b>Light Dimmers - Neutral Required</b>				
Dimmable	<b>WD300-WH</b>	<b>WD300-BK</b>	<b>WD300-G</b>	<b>WD300</b>
Description	Crystal Glass White Plate	Crystal Glass Black Plate	Crystal Glass Gold Plate	Light Dimming Module Max. Load (300W)





**NATIONAL CALL CENTRE:**  
**SALES - 010 202 3400**  
**TECHNICAL - 010 202 3500**

**LONGMEADOW**

26 Nguni Drive, Longmeadow  
Business Estate West, Edenvale  
Gauteng  
Tel: +27 10 202 3300  
Fax: +27 10 202 3365  
Email: info@acdc.co.za

**GERMISTON**

Sharland Street, Driehoek,  
Germiston, Gauteng  
Tel: +27 11 418 9600  
Fax: +27 11 418 9633  
Email: germiston@acdc.co.za

**CAPE TOWN**

Richmond Southern Close, Lenie  
Adams Avenue, Richmond Park  
Tel: +27 21 492 2000  
Fax: +27 87 807 5279  
Email: cape@acdc.co.za

**PAARDEN EILAND**

55 Section Street, Paarden Eiland,  
Cape Town  
Tel: +27 21 036 0996  
Email: thomash@acdc.co.za

**RIVERHORSE**

6 Riverhorse Close Riverhorse  
Valley Business Estate,  
Durban, Kwa-Zulu Natal  
Tel: +27 31 492 4800  
Fax: +27 87 405 0775  
Email: rvh@acdc.co.za

**PINETOWN**

Unit 10, Pine Industrial Estate  
Pineside Road, New Germany  
Pinetown, Kwa-Zulu Natal  
Tel: +27 31 700 4215  
Fax: +27 31 700 4330  
Email: kzn@acdc.co.za



THINK ELECTRICAL

**ORION MODULAR SOCKETS & SWITCHES**